

SANYO**LB1930M****Single-Channel Low Saturation Voltage
Forward/Reverse Motor Driver****Overview**

The LB1930M is a low saturation voltage H-bridge forward/reverse motor driver that supports low-voltage drive. This device is optimal for CD, MD, and cassette player loading motors.

Functions and Features

- The low saturation voltage reduces IC internal heating and allows a high voltage to be applied to the motor. Thus this device can be used even in environments with a high operating ambient temperature.
 - Output saturation voltage:
 - Vsat1 = 0.25 V typical ($I_O = 0.2$ A)
 - (High side + low side):
 - Vsat2 = 0.55 V typical ($I_O = 0.5$ A)
 - Operating temperature range:
 - Ta = -30 to +85°C
- The LB1930M features the wide operating voltage range of 2.2 to 10.8 V and the low standby current drain of 0.1 μ A, and therefore can easily be used in battery operated systems.
- To minimize through currents, the LB1930M internal logic passes through an internal standby state when switched by the input signals between forward/reverse and brake, or between forward and reverse.
- There are no constraints on the relationship between the input voltage and the supply voltage. For example, the LB1930M can be used with $V_{CC} = 3$ V, and $V_{IN} = 5$ V.

- If the IC chip exceeds 180°C due to an output short causing a large current flow, the built-in thermal protection circuit suppresses the drive current to prevent fires or destruction of the IC.
- MFP-10S miniature package. Also, the LB1930M features the high allowable power dissipation of $P_d = 800$ mW.

Package Dimensions

unit: mm

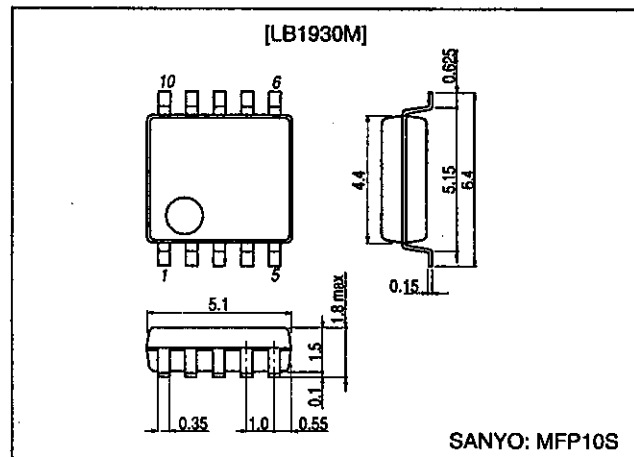
3148-MFP10S

■ Any and all SANYO products described or contained herein do not have specifications that can handle applications that require extremely high levels of reliability, such as life-support systems, aircraft's control systems, or other applications whose failure can be reasonably expected to result in serious physical and/or material damage. Consult with your SANYO representative nearest you before using any SANYO products described or contained herein in such applications.

■ SANYO assumes no responsibility for equipment failures that result from using products at values that exceed, even momentarily, rated values (such as maximum ratings, operating condition ranges, or other parameters) listed in products specifications of any and all SANYO products described or contained herein.

SANYO Electric Co., Ltd. Semiconductor Company

TOKYO OFFICE Tokyo Bldg., 1-10, 1 Chome, Ueno, Taito-ku, TOKYO, 110-8534 JAPAN

51199RM (OT) No. 6068-1/5

Specifications

Absolute Maximum Ratings at $T_a = 25^\circ\text{C}$

Parameter	Symbol	Conditions	Rating	Unit
Supply voltage	V_{CC} max		11	V
Output current	I_{OUT} max		1000	mA
Output voltage handling	V_{OUT} max		$V_{CC} + V_{SF}$	V
Applied input voltage	I_H max		10.5	V
Allowable power dissipation	P_d max	Mounted on the specified printed circuit board*	800	mW
Operating temperature	T_{opr}		-30 to +85	$^\circ\text{C}$
Storage temperature	T_{stg}		-55 to +150	$^\circ\text{C}$

Note *: $114.3 \times 76.1 \times 1.5$ mm³ glass epoxy printed circuit board

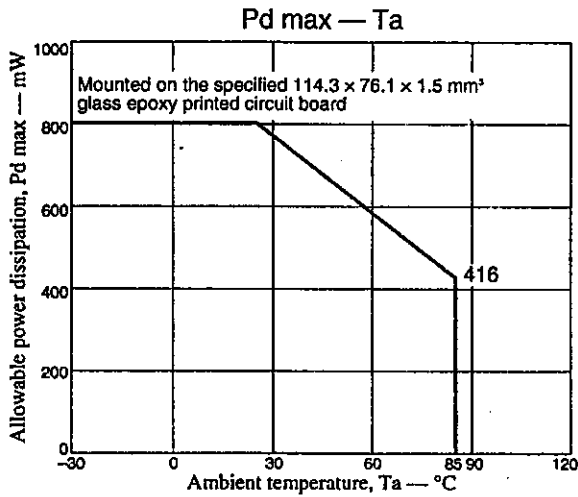

Allowable Operating Ranges at $T_a = 25^\circ\text{C}$

Parameter	Symbol	Conditions	Rating	Unit
Supply voltage	V_{CC}		2.2 to 10.8	V
High-level input voltage	V_{IH}		2.0 to 10	V
Low-level input voltage	V_{IL}		-0.3 to +0.3	V

Electrical Characteristics at $T_a = 25^\circ\text{C}$, $V_{CC} = 3$ V

Parameter	Symbol	Conditions	Rating			Unit
			min	typ	max	
Supply current	I_{CC1}	Standby mode		0.1	5	μA
	I_{CC2}	Forward or reverse drive operation		15	21	mA
	I_{CC3}	Braking		22	31	mA
Output saturation voltage	V_O (sat)1	Forward or reverse drive: High side + low side, $I_O = 200$ mA		0.25	0.35	V
	V_O (sat)2	Forward or reverse drive: High side + low side, $I_O = 500$ mA		0.55	0.75	V
	V_O (sat)3	Forward or reverse drive: High side only, $I_O = 200$ mA		0.15	0.25	V
Spark killer diode forward voltage	V_{SF}	$I_O = 200$ mA		0.9	1.7	V
Spark killer diode reverse current	I_{RS}	$V_{OUT} = 10$ V		0.1	5	μA
Input current	I_{IN}	$V_{IN} = 5$ V		70	95	μA
Thermal detection operating temperature	THD	Design target value*	150	180	200	$^\circ\text{C}$

Note *: This value is a design guarantee and is not measured.

LB1930M

Truth Table

IN1	IN2	OUT1	OUT2	Mode
L	L	OFF	OFF	Standby
H	L	H	L	Forward
L	H	L	H	Reverse
H	H	H	H	Brake

Pin Assignment

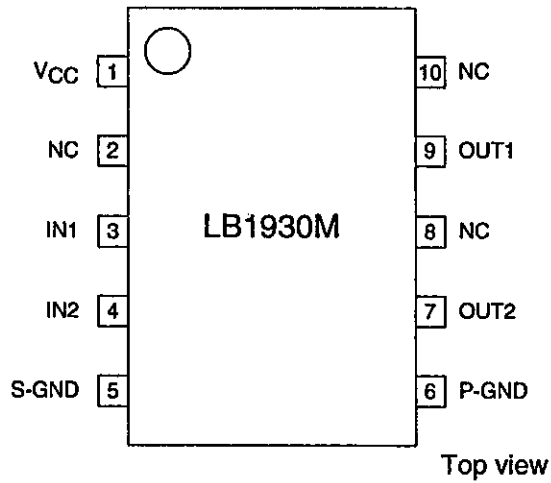

A11865

Block Diagram and Sample Application Circuit

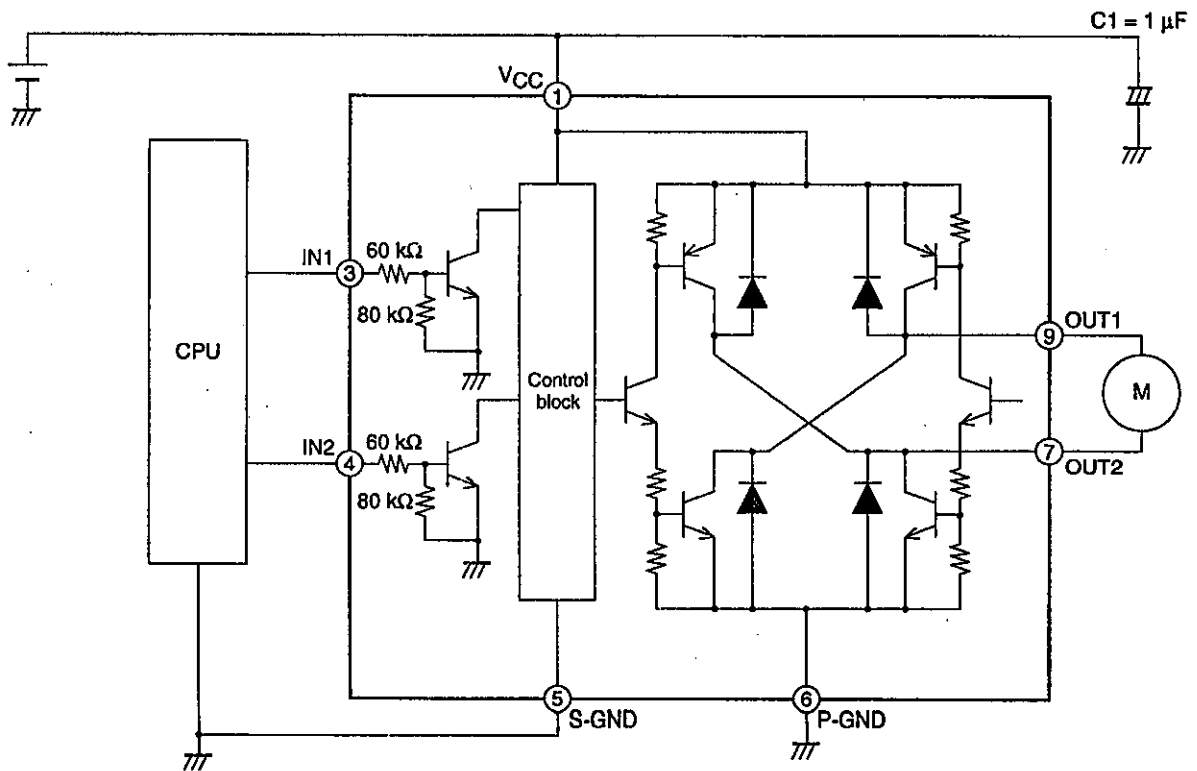

A11866

Usage Notes

Oscillation may occur in the V_{CC} and P-GND lines, since these lines carry a wide range of currents. The following may help if this is a problem.

- Lower the inductance of the wiring by making lines wider and shorter.
- Insert capacitors with good frequency characteristics close to the IC.
- Consider adopting the following methods if the CPU and this IC are mounted on different printed circuit boards that could easily have different ground potentials.

Connect S-GND to the CPU ground and connect P-GND to the power system ground.

Insert resistors of about 10 k Ω in series between the controller outputs and the inputs on this IC.

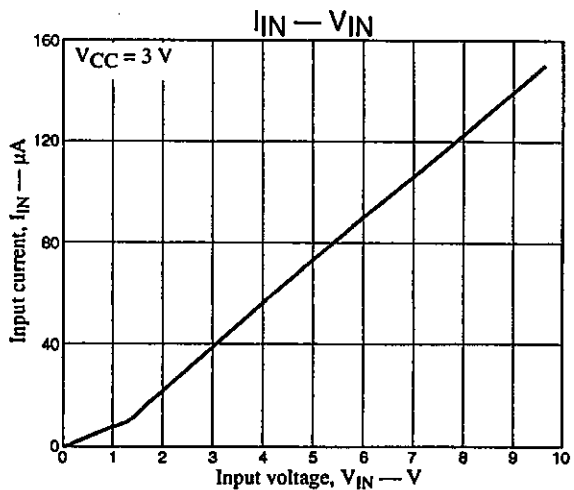
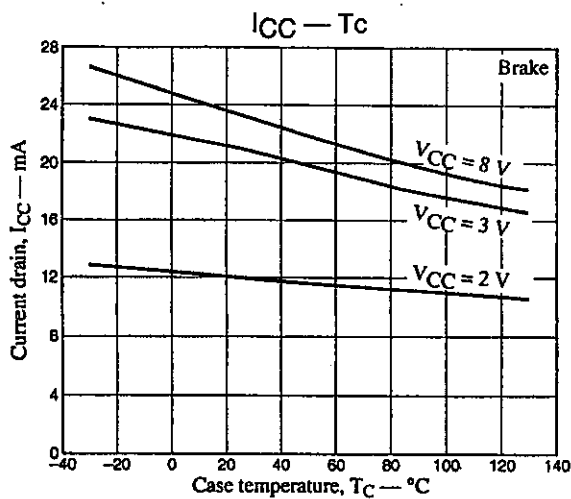
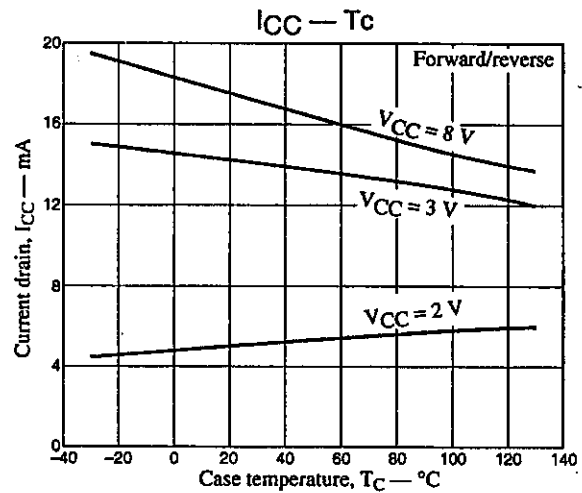
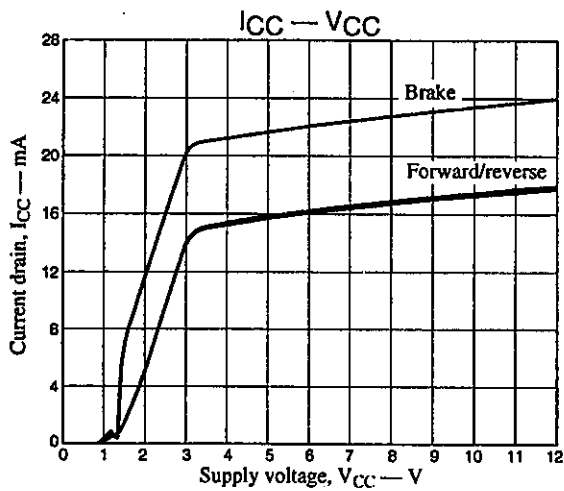
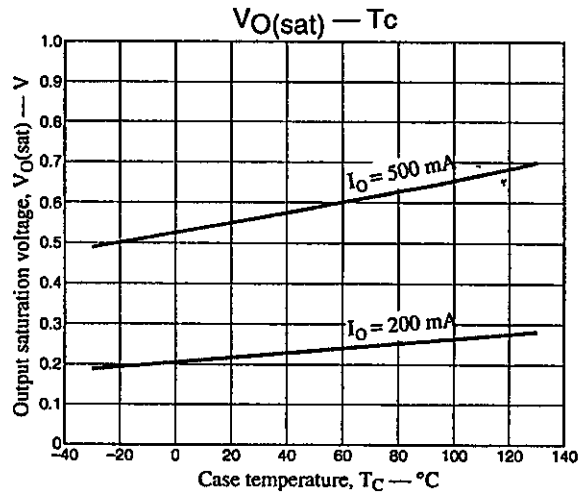
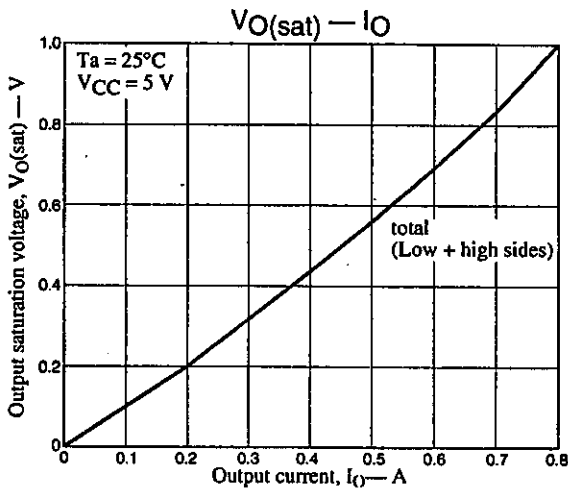

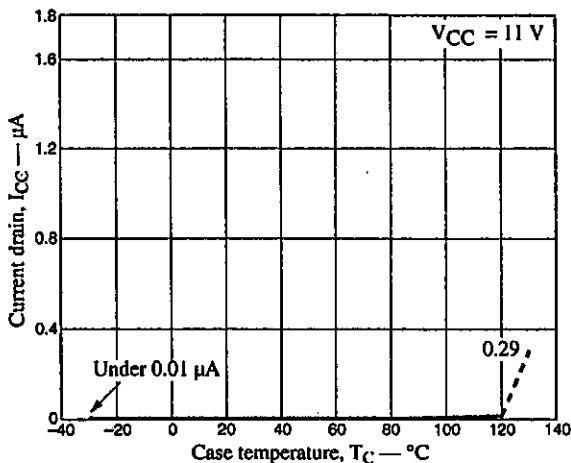
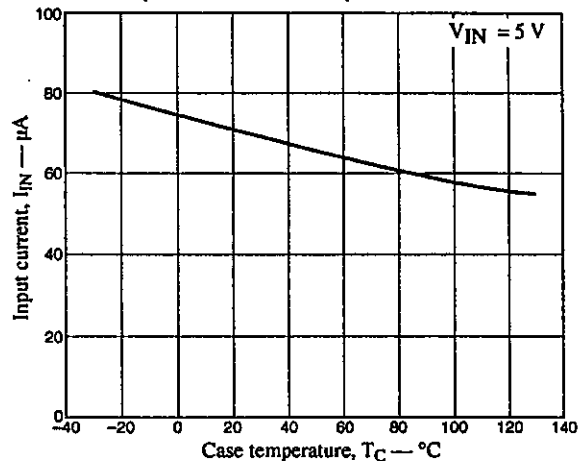
I_{CC} Standby Temperature CharacteristicsI_N Pin Input Current vs. Temperature Characteristics

- Specifications of any and all SANYO products described or contained herein stipulate the performance, characteristics, and functions of the described products in the independent state, and are not guarantees of the performance, characteristics, and functions of the described products as mounted in the customer's products or equipment. To verify symptoms and states that cannot be evaluated in an independent device, the customer should always evaluate and test devices mounted in the customer's products or equipment.
- SANYO Electric Co., Ltd. strives to supply high-quality high-reliability products. However, any and all semiconductor products fail with some probability. It is possible that these probabilistic failures could give rise to accidents or events that could endanger human lives, that could give rise to smoke or fire, or that could cause damage to other property. When designing equipment, adopt safety measures so that these kinds of accidents or events cannot occur. Such measures include but are not limited to protective circuits and error prevention circuits for safe design, redundant design, and structural design.
- In the event that any or all SANYO products (including technical data, services) described or contained herein are controlled under any of applicable local export control laws and regulations, such products must not be exported without obtaining the export license from the authorities concerned in accordance with the above law.
- No part of this publication may be reproduced or transmitted in any form or by any means, electronic or mechanical, including photocopying and recording, or any information storage or retrieval system, or otherwise, without the prior written permission of SANYO Electric Co., Ltd.
- Any and all information described or contained herein are subject to change without notice due to product/technology improvement, etc. When designing equipment, refer to the "Delivery Specification" for the SANYO product that you intend to use.
- Information (including circuit diagrams and circuit parameters) herein is for example only; it is not guaranteed for volume production. SANYO believes information herein is accurate and reliable, but no guarantees are made or implied regarding its use or any infringements of intellectual property rights or other rights of third parties.

This catalog provides information as of May, 1999. Specifications and information herein are subject to change without notice.